

2 - BEDROOM

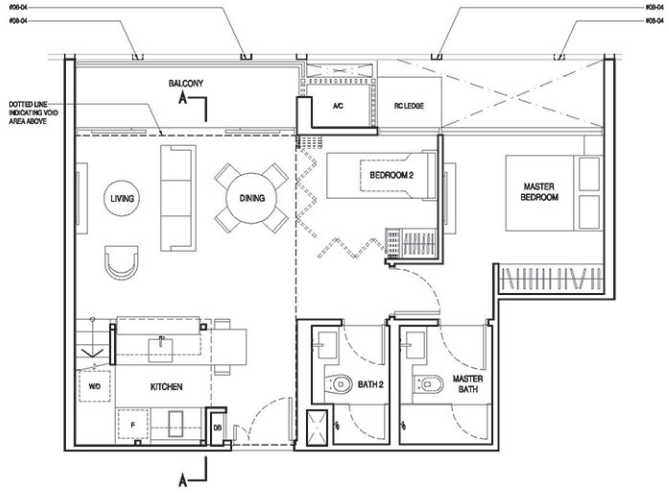

TYPE C1a
 97 sq.m. / 1,044 sq.ft. (including void area of 29 sq.m./312 sq.ft. above living, dining and kitchen)
 #05-04
 #03-04

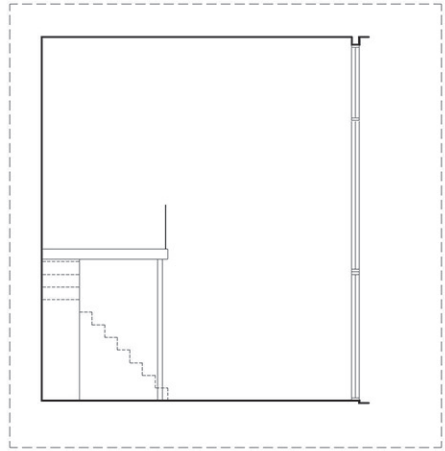

PART SECTION A-A
 FLOOR TO FLOOR 7.20 m. ABOVE LIVING/
 DINING AND KITCHEN

TYPE C1a

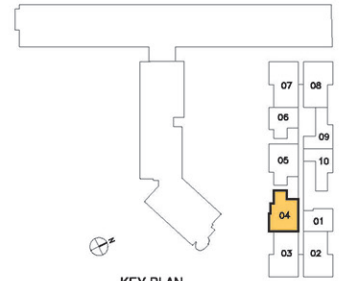

KEY PLAN
 (NOT TO SCALE)

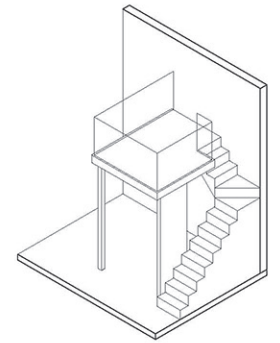

**ISOMETRIC VIEW OF
 FURNITURE DECK**
 (NOT TO SCALE)



2 - BEDROOM

TYPE C1a (PES)

105 sq.m. / 1,130 sq.ft. (including void area of 29 sq.m./312 sq.ft. above living, dining and kitchen)

#04-04

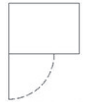

unit #04-04: including air-con condensers of 1 sq.m./11 sq.ft. accessory lift located on 3rd floor podium carpark

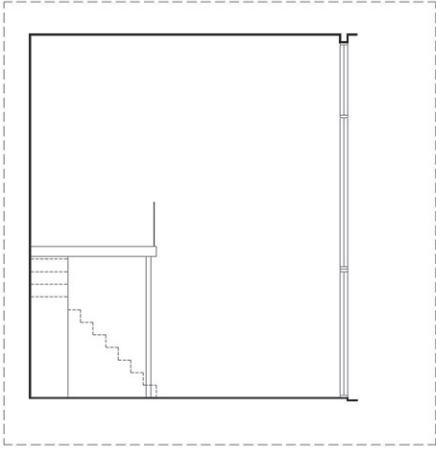
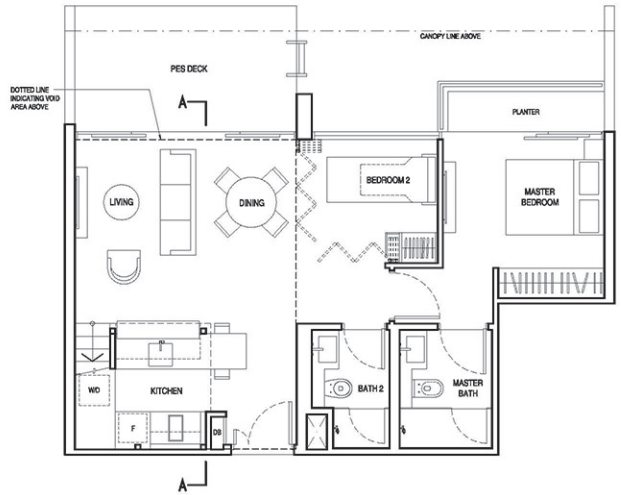

PART SECTION A-A
FLOOR TO FLOOR 7.20 m. ABOVE LIVING/
DINING AND KITCHEN

TYPE C1a (PES)

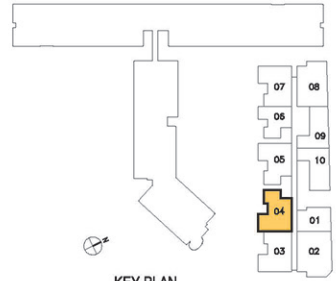

KEY PLAN
(NOT TO SCALE)

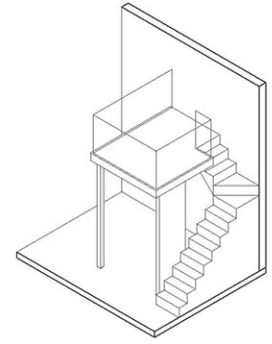

ISOMETRIC VIEW OF
FURNITURE DECK
(NOT TO SCALE)



2 - BEDROOM

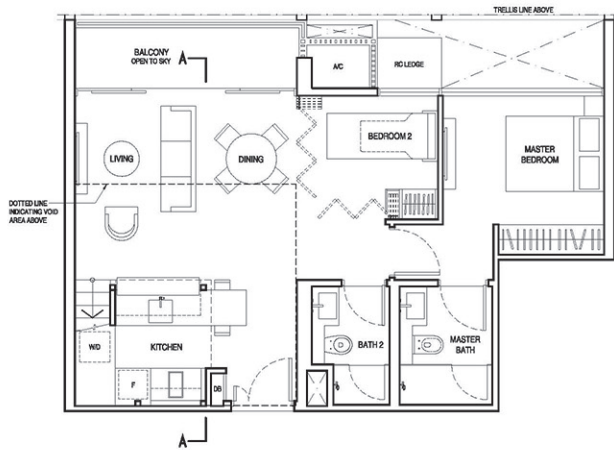

TYPE C1c

89 sq.m. / 959 sq.ft. (including void area of 21 sq.m./228 sq.ft. above living, dining and kitchen)

#10-04

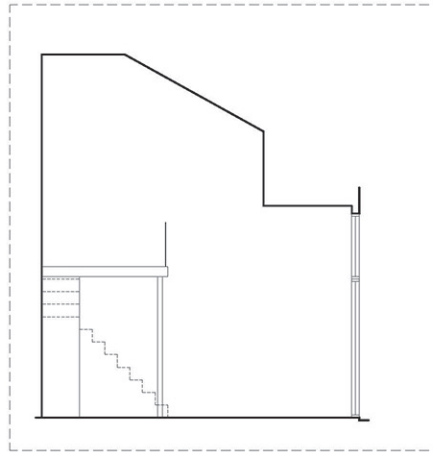

PART SECTION A-A

FLOOR TO ROOF VARIES FROM 4.20m TO 7.20m

TYPE C1c

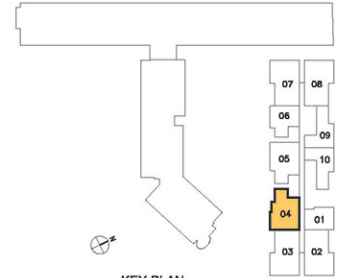

KEY PLAN
(NOT TO SCALE)

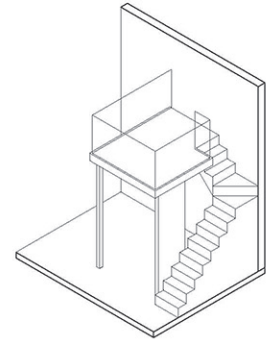

ISOMETRIC VIEW OF
FURNITURE DECK
(NOT TO SCALE)



2 - BEDROOM

TYPE C2 (PES)

78 sq.m. / 818 sq.ft.

#04-05



unit #04-05: including air-con condensers of 1 sq.m./11 sq.ft. accessory lot located on 3rd floor podium rooftop

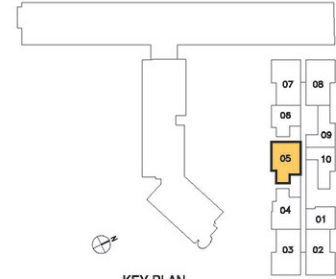
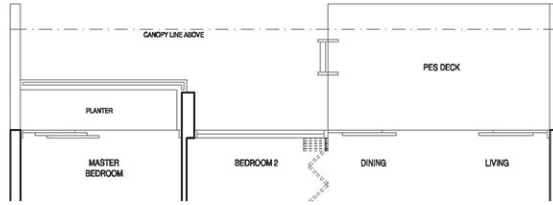

KEY PLAN
(NOT TO SCALE)

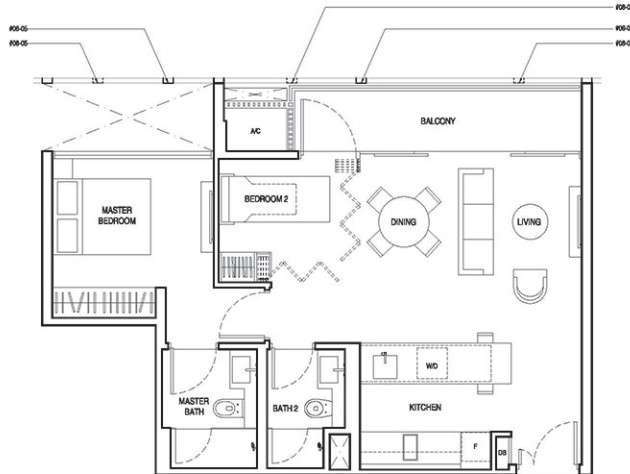

TYPE C2

70 sq.m. / 753 sq.ft.

#06-06

#08-05



2 - BEDROOM

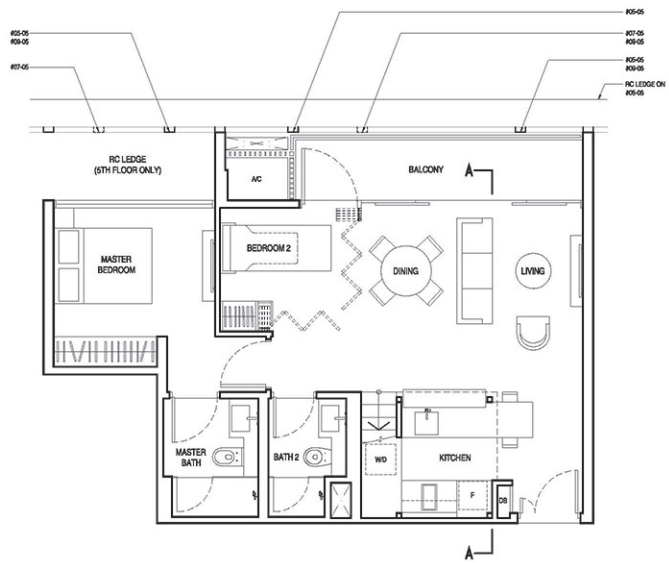

TYPE C2b
 70 sq.m. / 753 sq.ft.
 R05-05
 R07-05
 R09-05

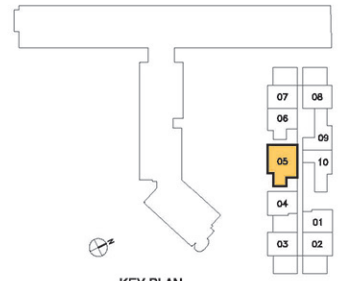

KEY PLAN
 (NOT TO SCALE)

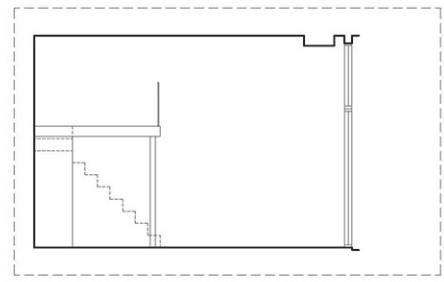

PART SECTION A-A
 FLOOR TO FLOOR 4.20m

TYPE C2b

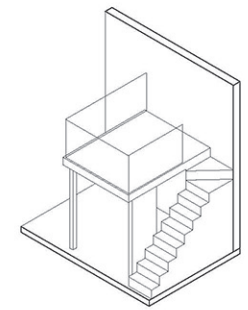

ISOMETRIC VIEW OF FURNITURE DECK
 (NOT TO SCALE)



2 - BEDROOM



KEY PLAN
(NOT TO SCALE)

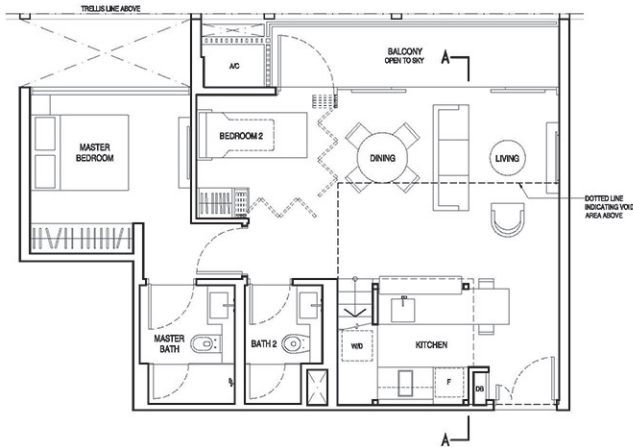

TYPE C2c
91 sqm / 980 sq ft. (including void area of 21 sqm/226 sq ft. above living, dining and kitchen)
#10-05

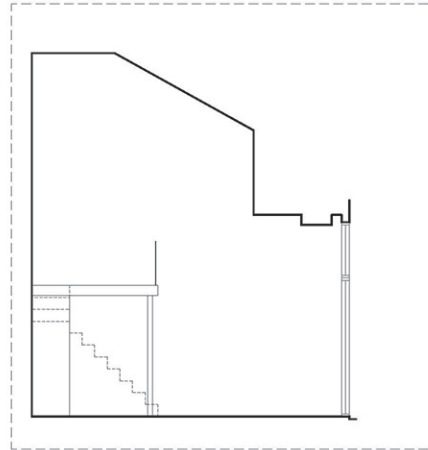

PART SECTION A-A
FLOOR TO ROOF VARIES FROM 4.20m TO 7.20m

TYPE C2c

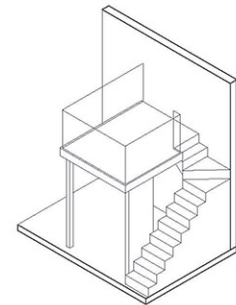

ISOMETRIC VIEW OF FURNITURE DECK
(NOT TO SCALE)



2 - BEDROOM

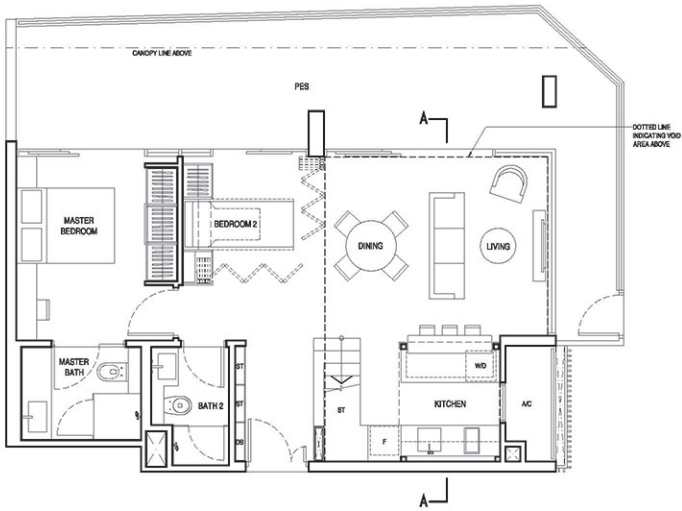

TYPE C3a1 (PES)

128 sq.m. / 1,378 sq.ft. (including void area of 26 sq.m./280 sq.ft. above living, dining and kitchen)

#04-02

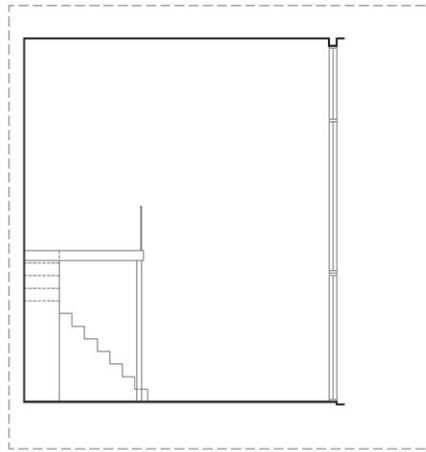

PART SECTION A-A

FLOOR TO FLOOR 7.20 m. ABOVE LIVING/
DINING AND KITCHEN

TYPE C3a1 (PES)

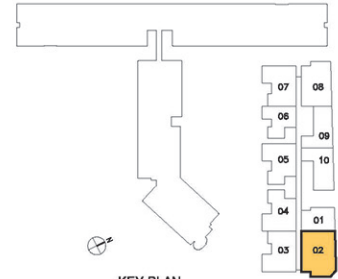

KEY PLAN
(NOT TO SCALE)

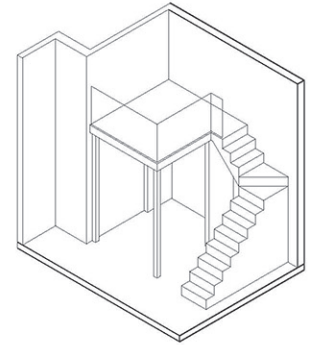

ISOMETRIC VIEW OF
FURNITURE DECK
(NOT TO SCALE)



2 - BEDROOM

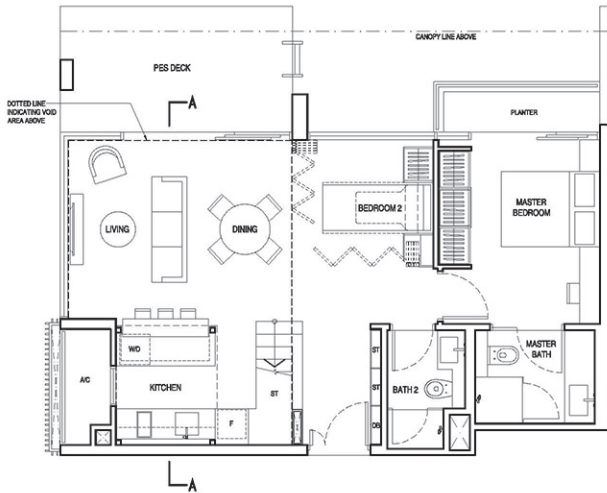

TYPE C3a2 (PES)

107 sq.m. / 1,152 sq.ft. (including void area of 28 sq.m./290 sq.ft. above living, dining and kitchen)

#04-03



KEY PLAN
(NOT TO SCALE)

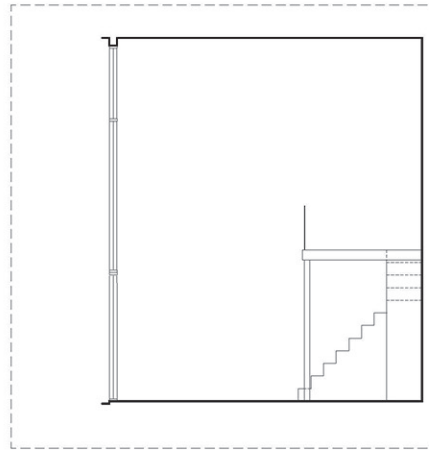

PART SECTION A-A
FLOOR TO FLOOR 7.20 m. ABOVE LIVING/
DINING AND KITCHEN

TYPE C3a2(PES)

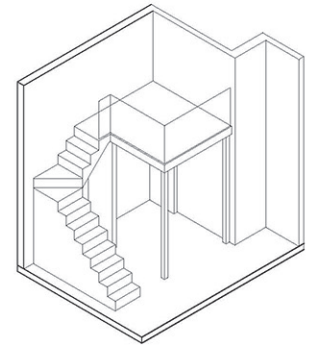

**ISOMETRIC VIEW OF
FURNITURE DECK**
(NOT TO SCALE)



2 - BEDROOM

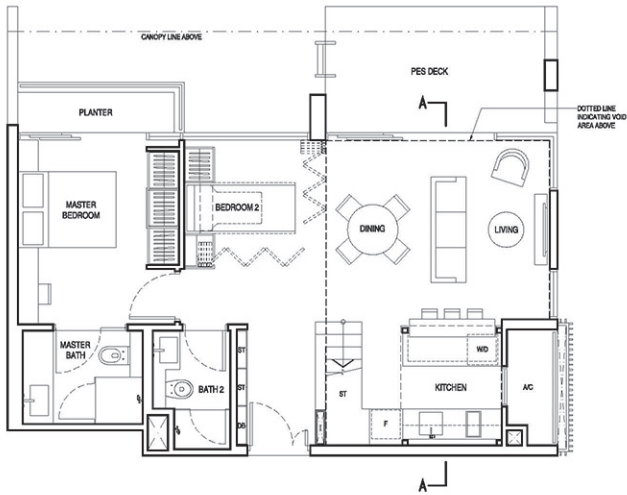

TYPE C3a3 (PES)

107 sq.m./1,152 sq.ft. (including void area of 26 sq.m./280 sq.ft. above living, dining and kitchen)

#04-07

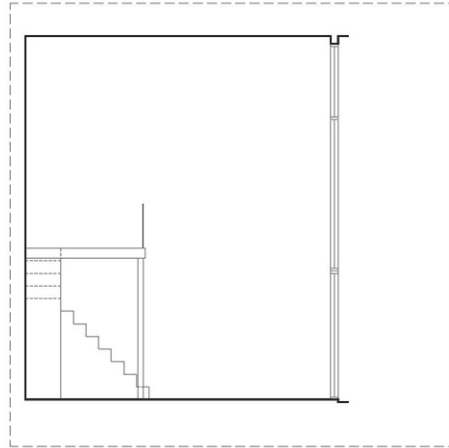

PART SECTION A-A

FLOOR TO FLOOR 7.20 m. ABOVE LIVING/
DINING AND KITCHEN

TYPE C3a3(PES)

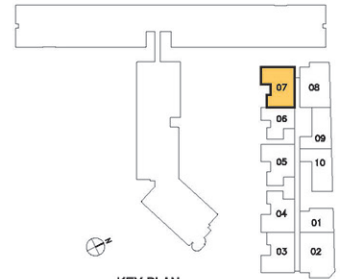

KEY PLAN
(NOT TO SCALE)

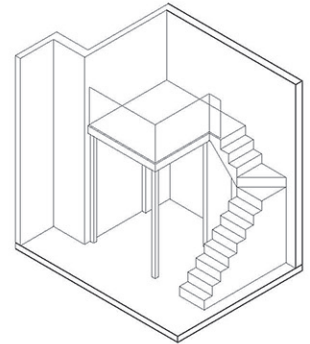

ISOMETRIC VIEW OF
FURNITURE DECK
(NOT TO SCALE)



2 - BEDROOM

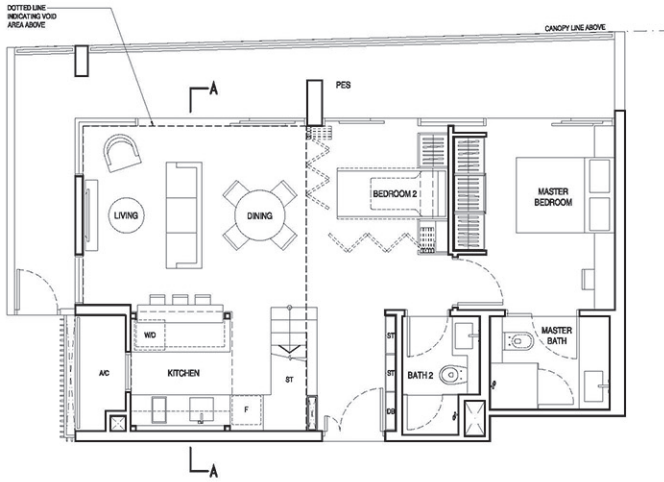

TYPE C3a4 (PES)

115 sq.m. / 1,238 sq.ft. (including void area of 29 sq.m./310 sq.ft. above living, dining and kitchen)

#04-08

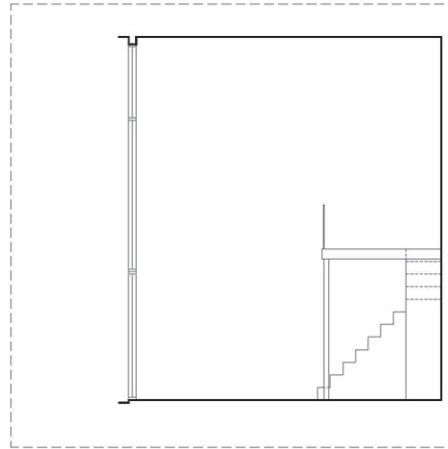

PART SECTION A-A
FLOOR TO FLOOR 7.20 m. ABOVE LIVING/
DINING AND KITCHEN

TYPE C3a4(PES)



KEY PLAN
(NOT TO SCALE)

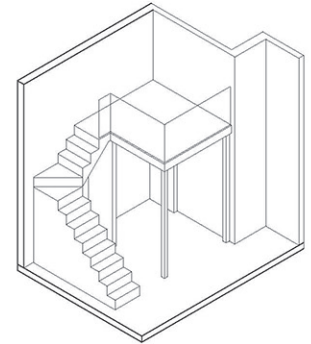

ISOMETRIC VIEW OF
FURNITURE DECK
(NOT TO SCALE)



2 - BEDROOM

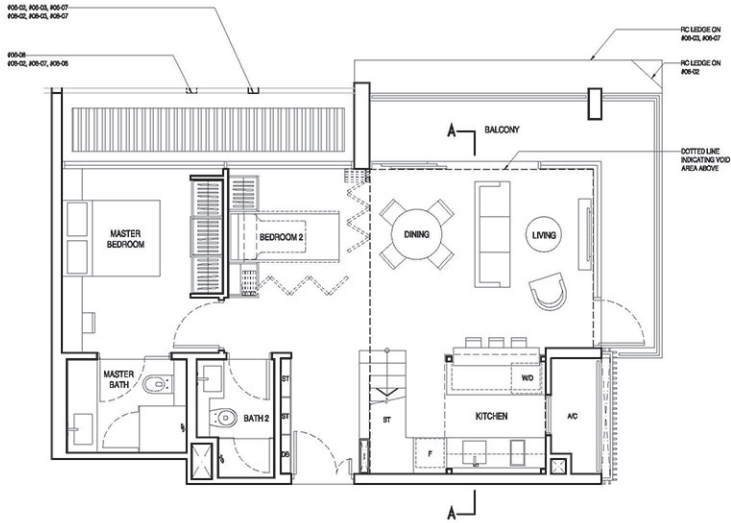

TYPE C3a

104 sq.m. / 1,119 sq.ft. (including void area of 26 sq.m./280 sq.ft. above living, dining and kitchen)

#05-02 #05-03 (MIRROR)
#05-07 #05-06 (MIRROR)
#05-02 #05-03 (MIRROR)
#05-07 #05-08 (MIRROR)

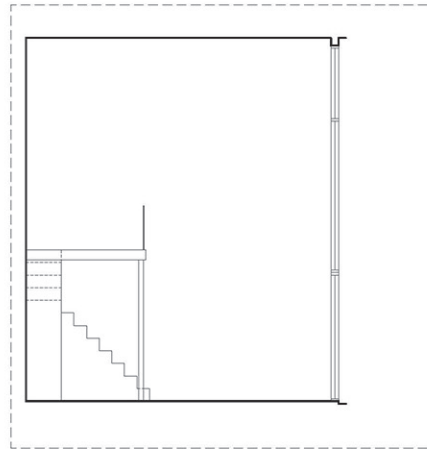

PART SECTION A-A

FLOOR TO FLOOR: 7.20 m. ABOVE LIVING/
DINING AND KITCHEN

TYPE C3a



KEY PLAN
(NOT TO SCALE)

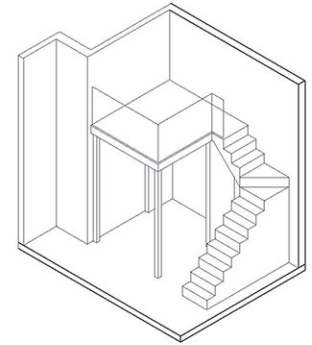

ISOMETRIC VIEW OF
FURNITURE DECK
(NOT TO SCALE)



2 - BEDROOM

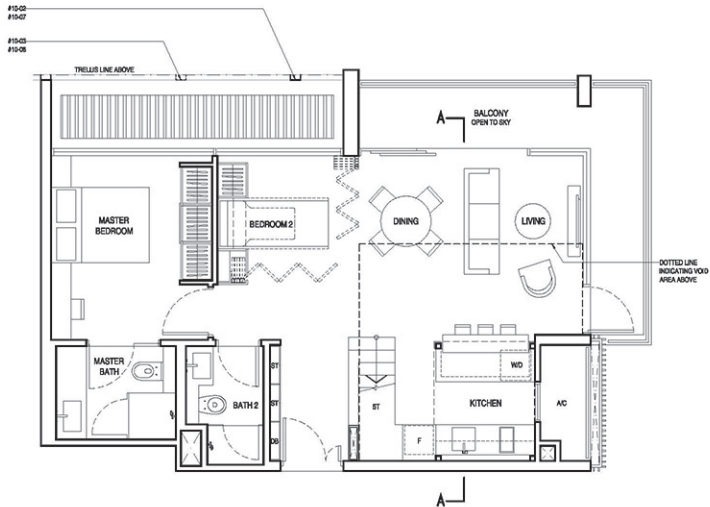

TYPE C3c

97 sq.m. / 1,044 sq.ft. (including void area of 19 sq.m./206 sq.ft. above living, dining and kitchen)

#10-02 #10-03 (MIRROR)
#10-07 #10-06 (MIRROR)

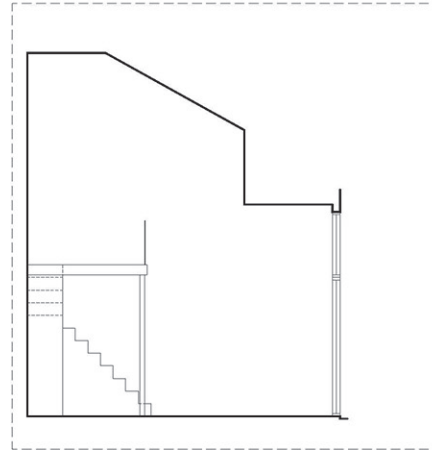

PART SECTION A-A

FLOOR TO ROOF VARIES FROM 4.20m TO 7.20m

TYPE C3c



KEY PLAN
(NOT TO SCALE)

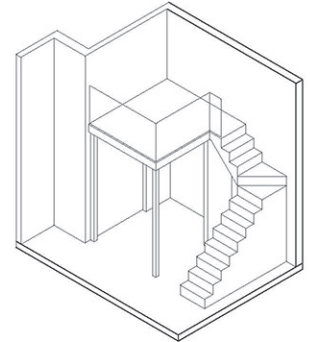

ISOMETRIC VIEW OF
FURNITURE DECK
(NOT TO SCALE)

